

WORLD MARKET®

Assembly Instructions

BLACK BAUBLE WOOD FLOOR LAMP

SKU-636415

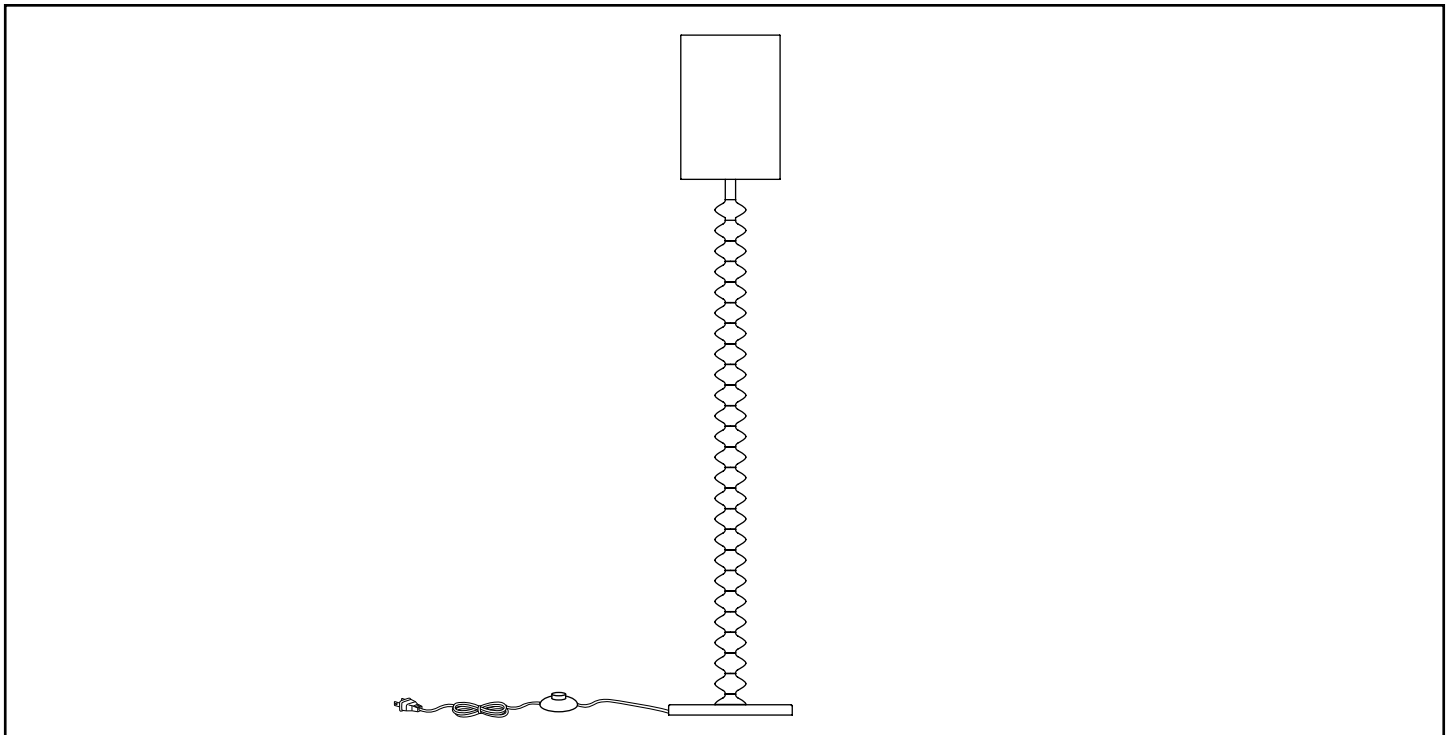

Thank you for your purchase. If you have any questions pertaining to the assembly of this lighting piece, please contact the nearest World Market store. If you are not near a store, please call our customer service call center toll free at 877-967-5362 for assistance.

ALL PRODUCTS SOLD AT WORLD MARKET ARE NOT
FOR COMMERCIAL USE AND ARE INTENDED FOR
RESIDENTIAL USE ONLY.

Component List

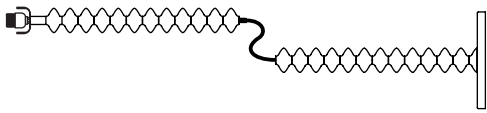
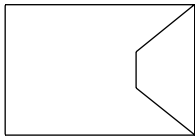
LABEL	COMPONENT	DESCRIPTION	QTY
A		UNO RING	1
B		LAMP BASE	1
C		LAMP SHADE (Included)	1

Assembly Preparation

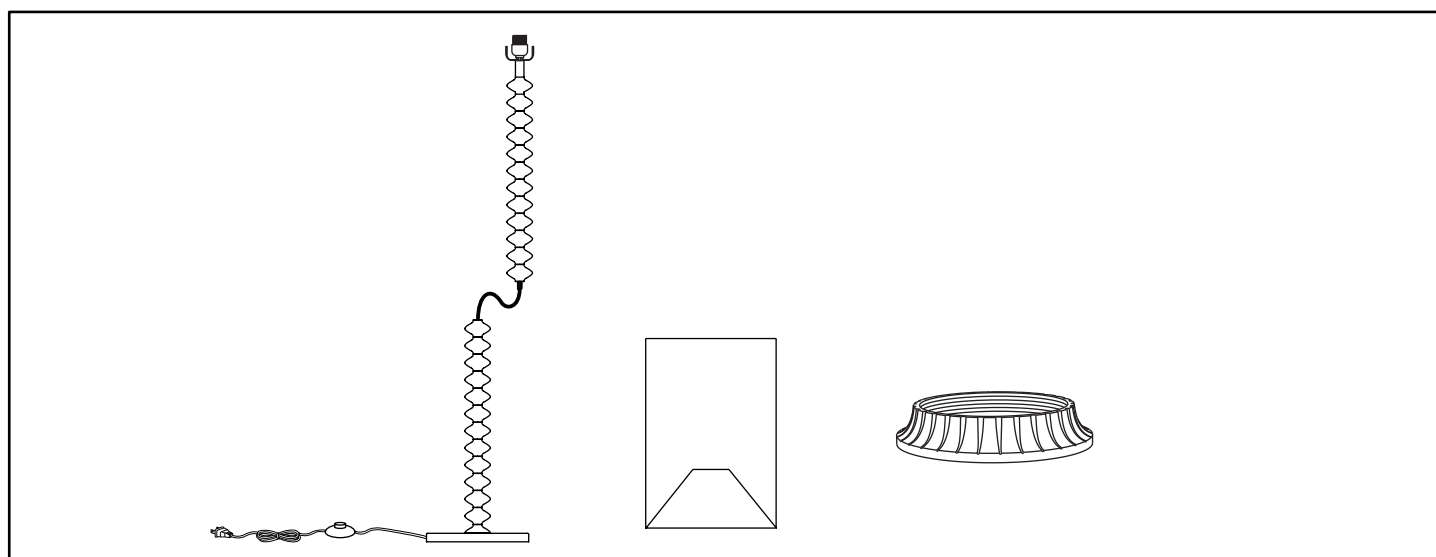

Read the assembly instructions, cover-to-cover. save any care and maintenance instructions pager for after the assembly has been completed.



It is always recommended to have 2 adults on hand for assembly.



Do not assemble on hard, abrasive flooring or carpeted surfaces that can damage or get caught in the components during assembly.

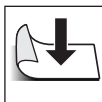

Assemble on a clean non-marring surface (such as the product's packing foam).

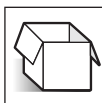

Do not discard any packaging until the product has been fully assembled.



In case of missing parts, please contact your nearest World Market store or call our customer service call center at 1-877-967-5362.



WARNING: Small parts are a choking hazard. Adult supervision is required before, during, and after

Assembly Steps

**! WARNING - ELECTRICAL FIXTURE.
PROFESSIONAL INSTALLATION RECOMMENDED.**

FOR YOUR SAFETY: Shut off the power to the main electric circuit supply before beginning any work. Lock out the circuit or the circuit breaker panel so the power can not be turned on while you are working. If handled improperly, electricity poses risk of personal injury or fire hazards. Professional installation is recommended.

STEP-1

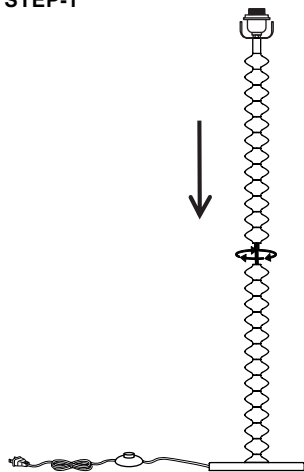

Step 1

Align stem sections of the Lamp Base (B) on top of each other and rotate the upper section clockwise to secure. DO NOT OVER TIGHTEN.

STEP-2

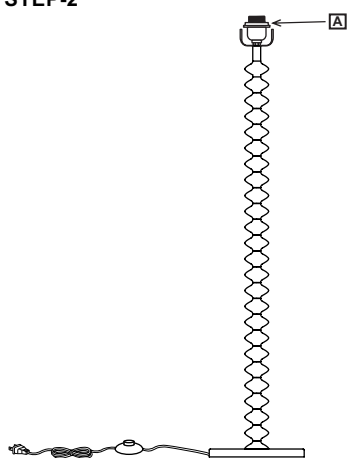

Step 2

Remove the Uno Ring (A) from the light socket by unscrewing it counter clockwise.

STEP-3

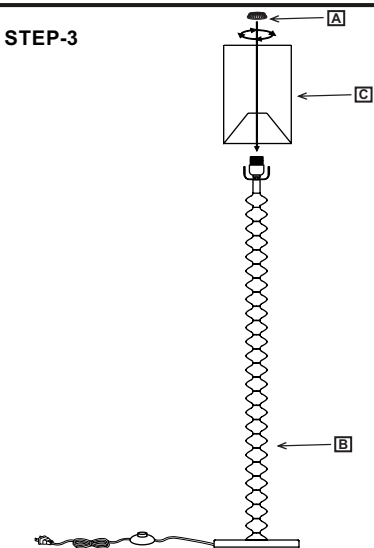

Step 3

Place Lamp Shade (C) onto the socket and secure by screwing Uno Ring (A) back onto socket clockwise until secured. Remove any plastic wrapping on Lamp Shade (C) before use.

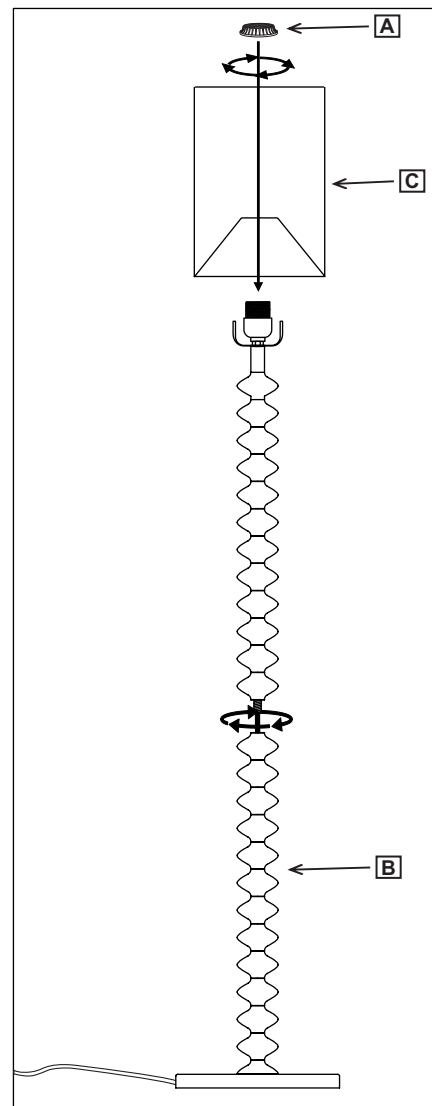

Bulb Installation

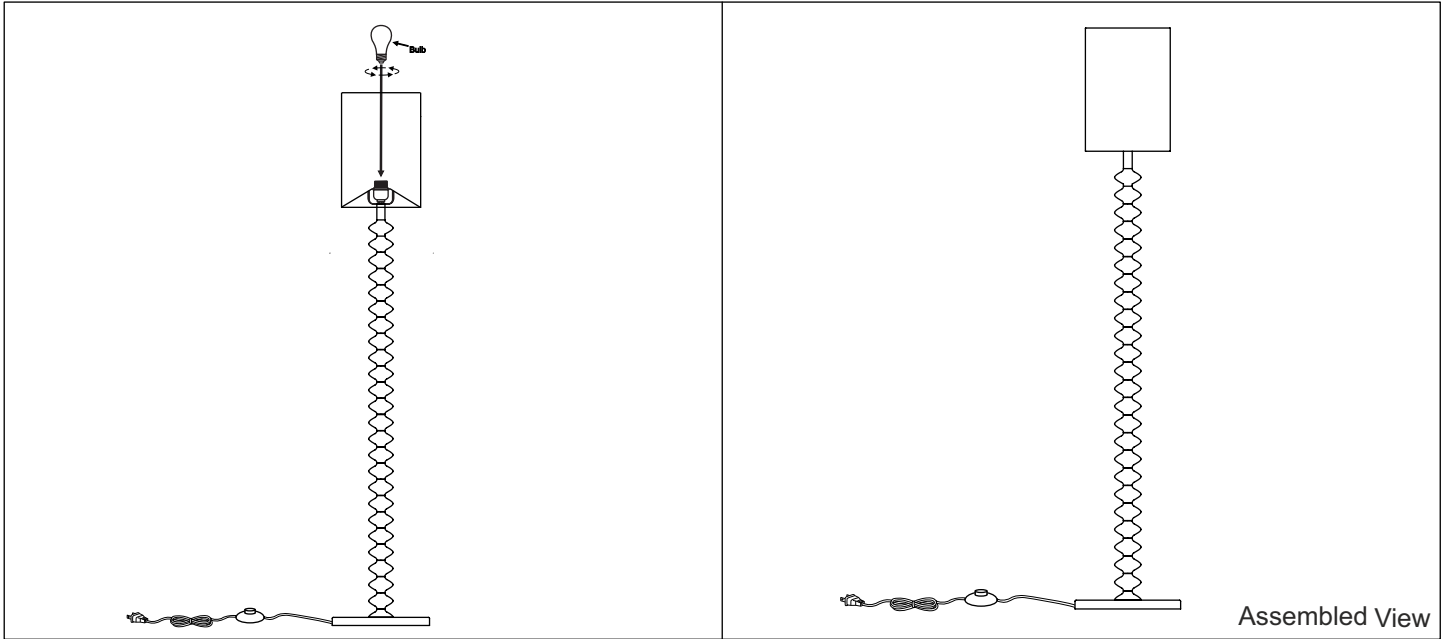

Insert Bulb (not included) into the socket and rotate it in clockwise to secure. Restore power to the circuit at this time and check for proper lighting operation. Assembly is now complete and the product is ready for use.

Warnings



All products sold at World Market are not for commercial use and are intended for residential use only.



To prevent the risk of fire, DO NOT use light bulbs with wattage greater than 100 Watt and 23 watt CFL. Use Type A Bulb for this product. Bulbs sold separately.



Never turn on power to the lamp until light bulb has been installed and assembly is completed.

Care & Maintenance



DO NOT clean Floor Lamp with harsh cleansers or polish.



DO NOT place Floor Lamp outside. For **INDOOR USE ONLY**.



Floor Lamp can be dusted using a clean, non-colored, lint-free dry cloth.